

100% Defence Oriented Unit

Vijay Engineers

**Mfg. of Precision parts, Load cells,
Defense components, SPM's and Automation.**



INTRODUCTION

We, M/s Vijay Engineers have been in the business of Engineering Equipment Manufacturing for Ordnance Factory Divisions of Ministry of Defense all over India. Machine components are manufactured as per customer's drawing specification. Also, we are equipped with the best Team that is committed to accomplish the given task without compromising on quality. We have Manufactured and supplied Special Purpose Machines as per requirement to Defense Divisions and have received Appreciation from Ministry of Defense. We have a well-established track record we have achieved customer satisfaction consistently. With quality manufacturing facilities and skilled workforce, we have been dealing in all kinds of machinery including critical parts for processing line machine.

OUR ACHIEVEMENTS

- 1) Appreciation from "Indian Economic Development & Research Association" New Delhi.
- 2) Appreciated for Development of Vital Import Substitute for Conveyor Transfer Bar Assembly 5.56 mm Bullet by Ammunition Factory Khadki – Pune.
- 3) Ordnance Factory Ambajhari were given the task to build a light weight bridge for the Indian Army, for which we have fulfilled the requirement of Joint Bands, Roller Launching, CSK fitted Assembly to Bridge shop for the development of Sub Assembly. Because of which we have been presented an Appreciation Letter by OFAJ.
- 4) Appreciation from CNAI(W) Indian Navy for the indigenization of signal flare launcher basket for KALVARI submarine.





APPRECIATION LETTERS FROM DEFENCE FACTORIES

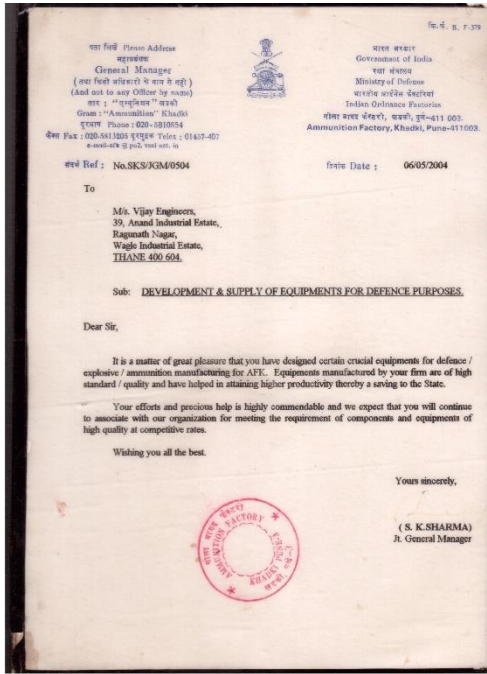

APPRECIATION LETTER FOR DEVELOPMENT OF CRUCIAL EQUIPMENT FOR DEFENCE PURPOSE FROM AFK.

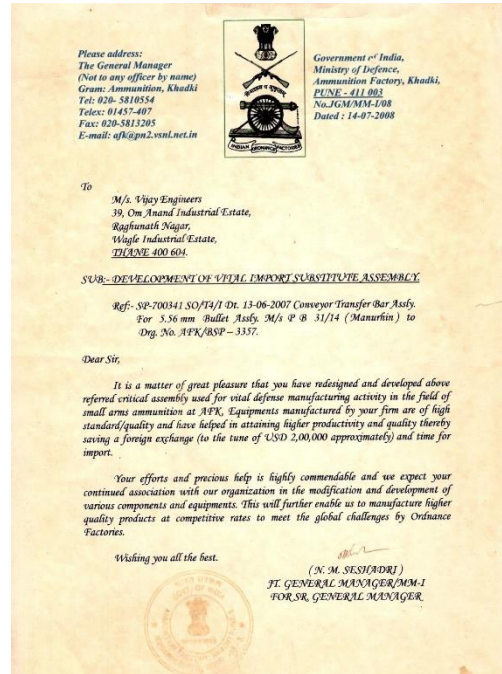

APPRECIATION LETTER FOR CONVEYOR TRANSFER BAR ASSEMBLY FOR 5.56MM BULLET ASSEMBLY FROM AFK.

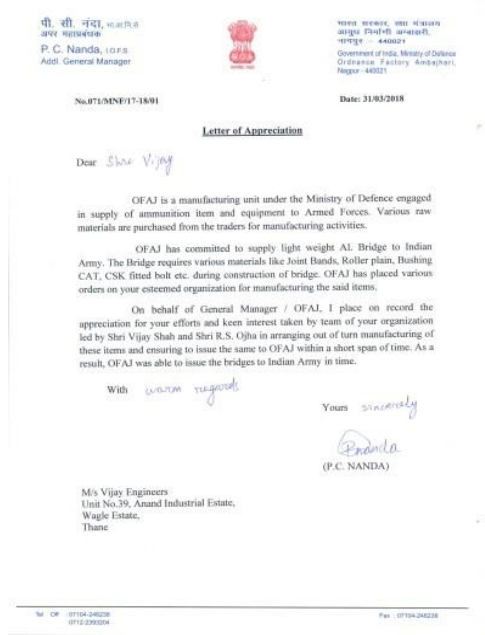

APPRECIATION LETTER FOR LIGHT WEIGHT ALUMINIUM BRIDGE TO INDIAN ARMY FROM OFAJ.

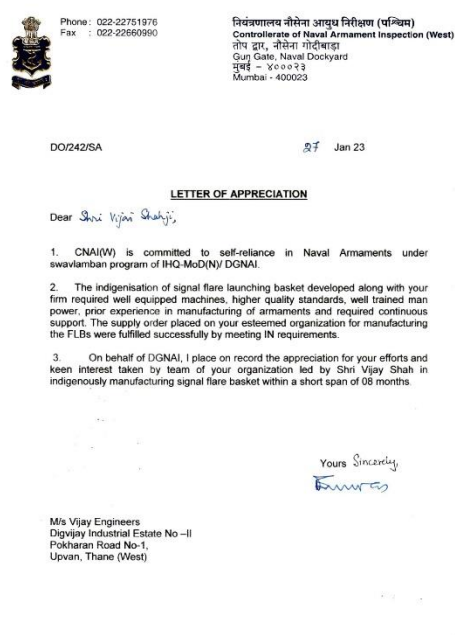

APPRECIATION LETTER FOR INDIGENISATION OF SIGNAL FLARE LAUNCHER BASKET FOR KALVARI SUBMARINE FROM CNAI(W), INDIAN NAVY.



BUSINESS DETAILS

Name of the Company: Vijay Engineers

Address: Digvijay Industrial Estate No. 02, Pokhran Road No – 01, Upvan, Thane (W) – 400606.

Contact No: 1) 9821402759 --- Mr. Vijay Shah (Proprietor)

2) 9702948485 ----Mr. Ravindra Oza (Marketing Head)

E-Mail ID: vijayengmumbai@yahoo.co.in

Website: www.vijayengineers.net

Year of Establishment: 1994

Constitution: Proprietor

Our GST Details: 27ACDPS5522L1ZA

We are registered with MSME, NSIC, ISO 9001 Certifications and under the Make in India initiative we are ZED Certified Unit, which was launched by the Government of India. We are also Certified by Quality Council of India.

All our raw material tests are carried out by NABL Accredited Laboratories. Each and every instrument is well calibrated at regular intervals.

We are also having In-house Heat Treatment facilities:

- 1) Muffle Furnace of Capacity – 900
- 2) Hot Air Oven



OUR CERTIFICATION

भारत सरकार
Government of India
सूक्ष्म, लघु एवं मध्यम उद्यम मंत्रालय
Ministry of Micro, Small and Medium Enterprises

MSME
2015, 2019 एवं 2022
MICR, MSME, & MSME (E) 2015

**UDYAM
REGISTRATION CERTIFICATE**

Our small hands to make you LARGE

UDYAM REGISTRATION NUMBER	UDYAM MH 35 085944		
NAME OF ENTERPRISE	VIJAY ENGINEERS		
TYPE OF ENTERPRISE*	MICRO (MICRO Debit Form: Financial Year)		
MAJOR ACTIVITY	MANUFACTURING		
SOCIAL CATEGORY OF ENTREPRENEUR	GENERAL		
NAME OF ENTERP	Name of Enterprise		
1	VIJAY ENGINEERS		
OFFICIAL ADDRESS OF ENTERPRISE	Factory Block: 02 Plot No: 1 Road No: 1 Area: 1000 Sq. Ft. Pin Code: 400606 State: MAHARASHTRA District: THANE Taluka: THANE (W) Mandla: 400606	Block: 02 Plot: 1 Road: 1 Area: 1000 Sq. Ft. Pin Code: 400606 State: MAHARASHTRA District: THANE Taluka: THANE (W) Mandla: 400606	INDUSTRIAL ESTATE, POKHARAN ROAD NO. 1, POKHARAN ROAD NO. 1, UPVAN, THANE (WEST), MAHARASHTRA, INDIA.
DATE OF INCORPORATION/REGISTRATION OF ENTERPRISE	11/09/2012		
DATE OF COMMENCEMENT OF PRODUCTION/BUSINESS	11/09/2012		
NATIONAL INDUSTRY CLASSIFICATION CODE(S)	28.11 Manufacture of fabricated metal parts, except screw threads and fittings	28.21 Manufacture of metal forgings, castings and metal parts	28.22 Manufacture of machine tools for turning, boring, milling, shaping, planing, grinding, etc.
DATE OF UDYAM REGISTRATION	12/02/2021		

BE A CHAMPION with the Ministry of MSME

UDYAM REGISTRATION CERTIFICATE

ZERTIFIKAT ♦ CERTIFICATE ♦ CERTIFICADO ♦ CERTIFICATE

UCS-UK

Certificate of Registration

This is to certify that
VIJAY ENGINEERS

OFFICE & FACTORY ADDRESS: DIGVIJAY INDUSTRIAL ESTATE II, POKHARAN ROAD I UPVAN, THANE (WEST)-400606, MAHARASHTRA, INDIA.

Has been assessed and found in as per ISO 9001:2015 compliance to the requirement of standard details below.

ISO 9001:2015
(QUALITY MANAGEMENT SYSTEM)

For The Following Scope Of Activities:
MANUFACTURES OF LOAD CELLS, PRECISION MACHINING, SHEET METAL PARTS, RECONDITIONING, DESIGNING AND AUTOMATION OF MECHANICAL, ELECTRICAL AND ELECTRONIC EQUIPMENTS FOR DEFENCE INDUSTRIES.

This certificate is property of Unitas Certification Services & remains valid subject to satisfactory surveillance audit.

Certificate No: 1384839
Surveillance Date: (25-FEB-2025)

Registration Date: (31-MAR-2022)
Certificate Expiry: (30-MAR-2025)

Chairman
Unitas Certification Services

The certificate is valid as long the organization's meet unitas certification services's requirements. The status of the certificate may be checked at www.unitascertificationservices.co.uk

UNITAS CERTIFICATION SERVICES
Head Office: 54 Emeraldale Close, Lake, Estare, Bletchley, Milton Keynes, Buckinghamshire, MK2 3DQ-UK
website: www.unitascertificationservices.co.uk / Email: info@unitscertificationservices.co.uk

ISO 9001:2015 REGISTRATION CERTIFICATE

Company Certificate

संघीय लघु उद्योग निगम लिमिटेड
THE NATIONAL SMALL INDUSTRIES CORPORATION LIMITED
(A Government of India Enterprise)

Branch Office: 1/104, Khairane MIDC, TTC Industrial Area, Koparkhairane, Navi Mumbai-400710
Ph: 022-27620865 Fax: 022-27634969
Email: bonum@nsic.co.in Website: www.nsic.co.in

GOVERNMENT PURCHASE ENLISTMENT CERTIFICATE

Renewal Certificate (Valid From 23/02/2022 to 22/02/2024)
Ref.No NSIC/MUM/GB/RS/V-185/041 Date: 23/03/2022

M/s. VIJAY ENGINEERS
DIGVIJAY INDUSTRIAL ESTATE NO.11, POKHARAN ROAD NO.1, UPVAN, THANE (WEST), THANE, MAHARASHTRA - 400506

Name of the Proprietor: MR. VIJAY N. SHAH
Constitution: Udyam Registration Enterprise Social Class: Special Category: Number: UDYAM/MSME/44-33-GENERAL-0259414

GOVERNMENT PURCHASE REGISTRATION NO: NSIC/GP/MUM/2016/020752
Monetary Limit: 1.80 Lacs (1 Eighty Lakh Only)
TURNOVER (Rupees in Lakhs)

Financial Year	Annual Turnover
2018-19	159.45
2019-20	87.59
2020-21	85.12
Monetary Limit	80

MSEs registered with NSIC are exempted from deposit of Earnest Money irrespective of value of Monetary Limit.

Your name has been registered as a MSE Unit eligible for participation in the Central Government Store Purchase Programme as per the Single Point Registration Scheme for the following item(s)/Store (s)/Service(s)

Name of the Store(s)/ Service(s)	Specifications	Qualitative Capacity	Quantitative Capacity P.A.
As per List Attached (12 item only)			

M/s. VIJAY ENGINEERS
Authorised Signatory

NSIC REGISTRATION CERTIFICATE

ZED
ZERO DEFECT - ZERO DEFECT

Ministry of Micro, Small & Medium Enterprises
and
Quality Council of India
awards
BRONZE RATING
under Financial Support to MSMEs in ZED Certification Scheme
to
VIJAY ENGINEERS

Certified Unit Address: DIGVIJAY INDUSTRIAL ESTATE NO.11, POKHARAN ROAD NO.1, UPVAN, THANE (WEST), Thane, Maharashtra - 400606

MS Code as per MS 1800: 28221
UAM No: MH32000239112
Number of Parameters Assessed: 38
Rating Agency: TÜV India Pvt. Ltd.

Issue Date: 30/03/2022

ZED REGISTRATION CERTIFICATE



LIST OF FEW SPM MACHINES SUPPLIED TO DEFENSE DIVISIONS:

1. Two Head Liner Weighing Machine – Ordnance factory Bhandara.
2. Salt Spray Apparatus – Ammunition factory Khadki, Pune.
3. Integration Trolley - Ordnance factory Ambajhari, Nagpur.
4. CE Stemming Equipment – Ordnance factory Badmal, Bolangir.
5. Caulking Equipment – Machine Tool Prototype factory, Ambernath.
6. Centre of Gravity Measuring Machine – Ordnance factory Muradnagar/Ordnance factory Khamaria, Jabalpur.
7. Critical Stores/Assemblies developed for Dhanush Gun for Gun Carriage factory, Jabalpur.
8. Vacuum Cleaning Machine for cleaning of PINAKA POD 5.5 meters long at Ordnance factory Chanda, Chandrapur.
9. Supply of Painting Booth Assembly for painting of Shell body of Pinaka Missiles to Ordnance factory Chanda, Chandrapur.
10. Manufacturing & Supply of Primer Electric 1AL full body Assembly to Ordnance factory Chanda, Chandrapur.



My Company, my team is fully committed to complete the given task without compromising on quality. We have been consistently Manufacturing for Ordnance factories all over India since 1994. We are undergoing business developments and we are constantly evolving to make sure that we meet our customers' requirements. We have always maintained a positive approach in our work and it has always been our strength.

We are looking forward to the Make in India initiative for Defense Industries, we can offer optimum quality products in timely delivery with more investment if we get good order assurance for long term business.

Mr. Vijay Shah
Proprietor

OUR PRODUCTS & CUSTOMERS INDIAN NAVY

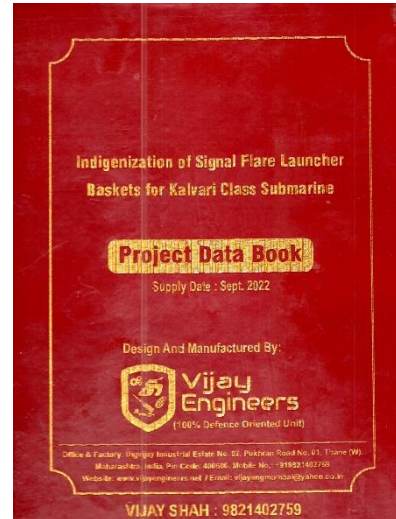
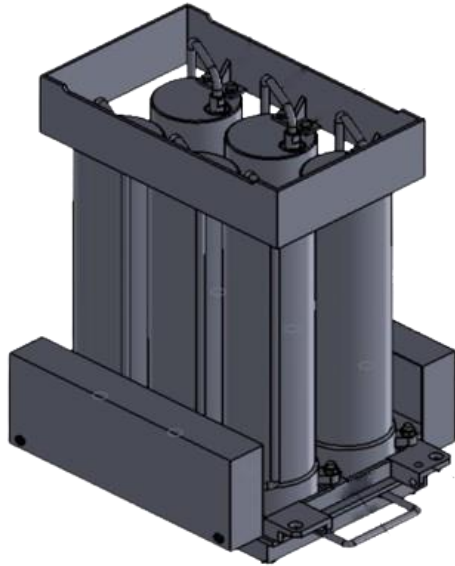

FLARE LAUNCHER BASKET FOR KALVARI CLASS SUBMARINE

OUR PRODUCTS & CUSTOMERS GLIDERS INDIA LIMITED



COIL SPRING WITH CONE Ordnance Parachute factory, Kanpur



OUR PRODUCTS & CUSTOMERS

MUNITIONS INDIA LIMITED

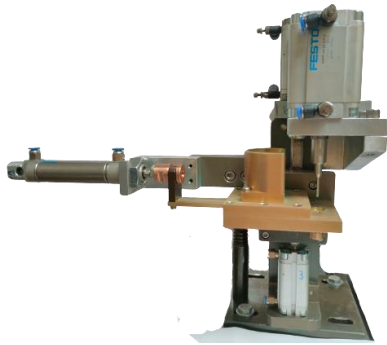

CE STEMMING EQUIPMENT
Ordnance factory Bolangir, Badmal



Vacuum Cleaning Machine
For Pinaka POD Cleaning
Ordnance factory Chanda, Chandrapur



ADAPTOR NOSE
Ordnance factory Chanda, Chandrapur



TRANSPORT JAR
Ordnance factory Bhandara



CONVEYORS
Ordnance factory Varangaon



FILLING & SEALING MACHINE
Ordnance factory Khamaria, Jabalpur



OUR PRODUCTS & CUSTOMERS

MUNITIONS INDIA LIMITED

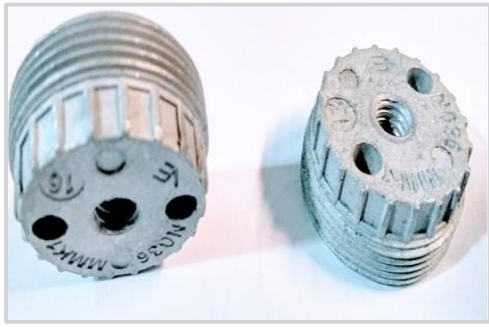

BASE PLUG

Ammunition factory Khadki, Pune

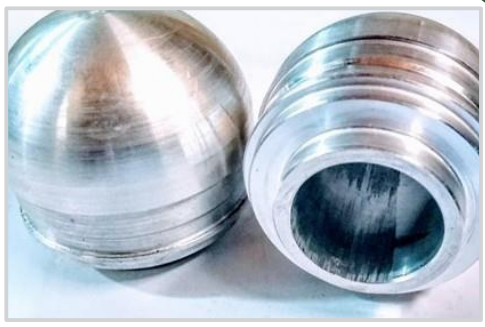

MODIFIED PRF

Ammunition factory Khadki, Pune



TWO HEAD LINER WEIGHING MACHINE

Ordnance factory Bhandara



CENTER OF GRAVITY MARKING & MEASURING MACHINE FOR AERIAL BOMB (250KG & 450KG) AND 1000 LB

Ordnance factory Khamaria
Ordnance factory Muradnagar



FIRE HOLE DRILLING MACHINE

Ammunition factory Khadki, Pune



VITAL DEFENCE SPARES



OUR PRODUCTS & CUSTOMERS

MUNITIONS INDIA LIMITED



PRIMER ELECTRIC 1 AL
Ordnance factory Chanda, Chandrapur



VACUUM TESTING EQUIPMENT
Ordnance factory Khamaria, Jabalpur



PICK AND PLACE MACHINE
Ordnance factory Khamaria, Jabalpur



PALLET TRUCK
Ammunition factory Khadki, Pune



FIRE TRANSMITTING TUBE
Ordnance Factory Chanda



OUR PRODUCTS & CUSTOMERS

YANTRA INDIA LIMITED

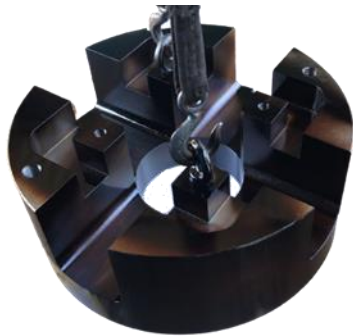

ROLLER HOUSING
Ordnance factory Ambajhari



LOCKING LEVER
Ordnance factory Ambajhari



ANCHOR STOCK
Ordnance factory Ambajhari



LOCKING BOLT
Ordnance factory Ambajhari



ADAPTOR PIERCER
Ordnance factory Katni



**HEAT SEALER FOR
PVC BAGS**
Ordnance factory Ambarnath



OUR PRODUCTS & CUSTOMERS

ADVANCED WEAPONS AND EQUIPMENT INDIA LIMITED



HAND PUMP WITH ASSY
Gun Carriage Factory, Jabalpur



GREASE GUN ASSY
Gun Carriage Factory, Jabalpur



HANDLE LEFT RIGHT
Gun Carriage Factory, Jabalpur



TOWING EYE
Gun Carriage Factory, Jabalpur



**DEVELOPMENT OF GABLE
(INVESTMENT CASTING)
BY 3D PRINTING**
Gun Carriage Factory, Jabalpur



RAMMER HEAD
Gun Carriage Factory, Jabalpur

OUR PRODUCTS & CUSTOMERS
ADVANCED WEAPONS AND EQUIPMENT INDIA
LIMITED



BRACKET LEFT
INVESTMENT CASTING
Gun Carriage Factory, Jabalpur



BRACKET
Gun Carriage Factory, Jabalpur

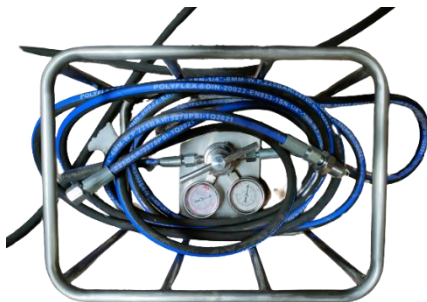

GAS FILLING UNIT
Gun Carriage Factory, Jabalpur



TRIAL SPADE CASTING
Gun Carriage Factory, Jabalpur



LOWER & UPPER COVER
Gun Carriage Factory, Jabalpur

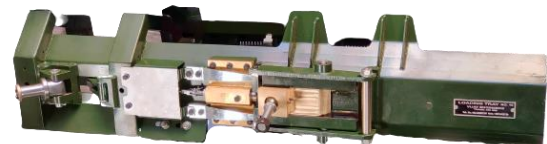

LOADING TRAY
Gun Carriage Factory, Jabalpur



OUR PRODUCTS & CUSTOMERS
ADVANCED WEAPONS AND EQUIPMENT INDIA
LIMITED



**DEVELOPMENT OF
BEARING HOUSING
(INVESTMENT CASTING)**
Gun Carriage Factory, Jabalpur



RELIEVING TOOL ASSY
Gun Carriage Factory, Jabalpur



BUFFER ASSEMBLY
Gun Carriage Factory, Jabalpur



**OUTER CASE LEFT AND
RIGHT ASSEMBLY**
Gun Carriage Factory, Jabalpur



**DEVELOPMENT OF
HOUSING LEFT
(INVESTMENT CASTING)**
Gun Carriage Factory, Jabalpur



OUR PRODUCTS & CUSTOMERS

ARMOURED VEHICLES NIGAM LIMITED



DRUM PRESSURE ASSY
Heavy Vehicles Factory, Avadi



DRIVE GEAR
Heavy Vehicles Factory, Avadi



CAULKING EQUIPMENT
Machine tool prototype factory,
Ambernath



IGB STAND
Machine tool prototype factory,
Ambernath



AZIMUTH INDICATOR
Machine tool prototype factory,
Ambernath



**HYDRAULIC COUPLING WITH
SHAFT ASSY**
Machine Tool Prototype Factory,
Ambernath



100% Defence Oriented Unit

Vijay Engineers

**Mfg. of Precision parts, Load cells,
Defense components, SPM's and Automation.**

 Plot no. 02, Digvijay Industrial estate,
Pokhran rd. 01 Upvan, Thane-west
Maharashtra, India

 +91-9821402759